

1

2

3

4

Notes: (Unless Otherwise Specified)

- 1. Waterproof Rate: Unmated IP67
- 2. Recommend Panel Thickness: 0.8 to 3.0 mm.
- 3. RoHS Compliant.

REV	ECN#	DESCRIPTION OF REVISION	DRAW BY DATE	CHECK BY DATE	APPROVE BY DATE
01			Hank 09/13/22	Lucas 09/13/22	Ray 09/13/22

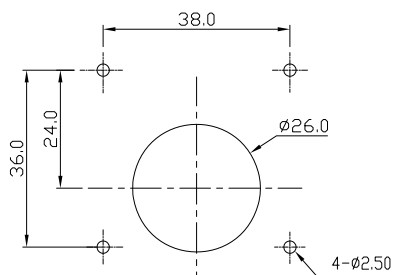
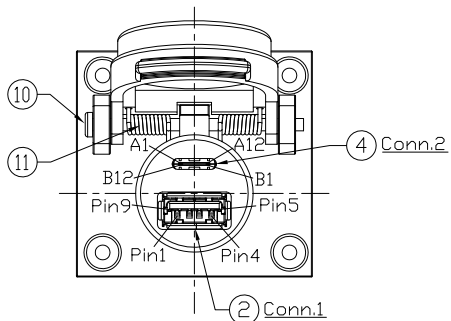
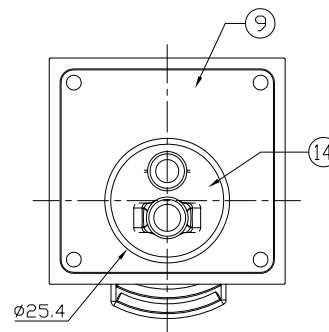
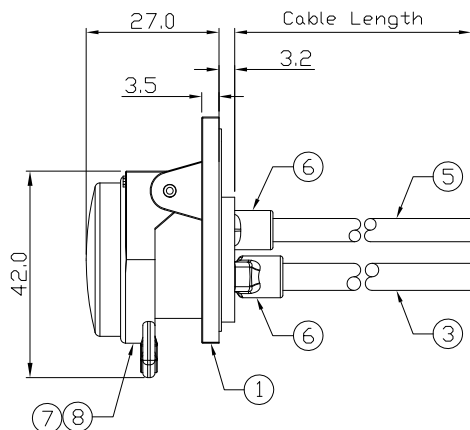
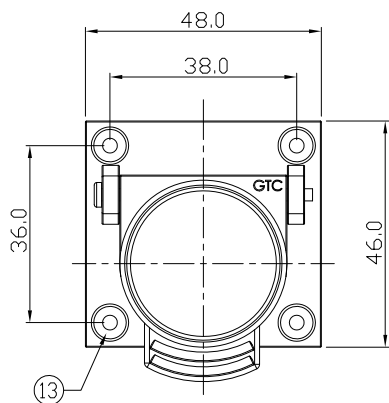

Recommend
Panel Cut-Out
Scale 1:1

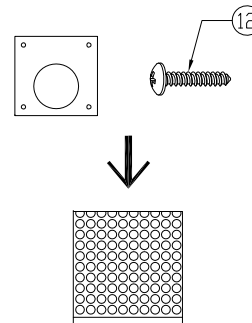

GT11F 443-0F-10	10000mm	+500
GT11F 443-0F-09	9000mm	+450
GT11F 443-0F-08	8000mm	+400
GT11F 443-0F-07	7000mm	+150
GT11F 443-0F-06	6000mm	+150
GT11F 443-0F-05	5000mm	+150
GT11F 443-0F-04	4000mm	+150
GT11F 443-0F-03	3000mm	+100
GT11F 443-0F-02	2000mm	+100
GT11F 443-0F-01	1000mm	+50
GT11F 443-0F-Z9	900mm	+50
GT11F 443-0F-Z8	800mm	+50
GT11F 443-0F-Z7	700mm	+50
GT11F 443-0F-Z6	600mm	+50
GT11F 443-0F-Z5	500mm	+50
GT11F 443-0F-Z4	400mm	+50
GT11F 443-0F-Z3	300mm	+25
GT11F 443-0F-Z2	200mm	+25
Part No.	Cable Length	Tol.

TITLE						DRAWING NUMBER			REV.
USB-A3.0 + Type-C C4 Panel Square Flange Dual-USB JACK With Cable + Cap						GT11F 443-0F-XX			01
THIRD ANGLE PROJECTION	SIZE	SCALE	DRAW / DATE	CHECK / DATE	APPROVE / DATE	TOLERANCES	UNIT	SHEET	
	B	1:1	Hank 09/13/22	Lucas 09/13/22	Ray 09/13/22	X.X ± 0.5 X.XX ± 0.2	X.XXX ± 0.05 ANGLES ± 1°	mm 1/2	

GT Contact CO.,LTD

NOTICE OF PROPRIETARY PROPERTY:
THE INFORMATION CONTAINED HEREIN IS THE PROPRIETARY PROPERTY OF GT Contact CO.,LTD THE POSSESSOR AGREES TO THE FOLLOWING:
(i) TO MAINTAIN THIS DOCUMENT IN CONFIDENCE
(ii) NOT TO REPRODUCE OR COPY IT
(iii) NOT TO REVEAL OR PUBLISH IT IN WHOLE OR PART
(iv) ALL RIGHTS RESERVED

1

2

3

4

1

2

3

4

REV	ECN#	DESCRIPTION OF REVISION	DRAW BY DATE	CHECK BY DATE	APPROVE BY DATE
01			Hank 09/13/22	Lucas 09/13/22	Ray 09/13/22

14	Glue	Epoxy Color: Black	
13	Screw Gasket	EPDM Color: Black	4
12	Screw	Stainless(TP1) Finish:-	4
11	Spring	Stainless Finish:-	1
10	Rivet	Aluminum Finish:-	1
9	Gasket	Silicone Color: Black	1
8	Cap Rubber Pad	Silicone Color: Black	1
7	Cap	Thermoplastic Color: Black	1
6	Over Mold	Thermoplastic Color: Black	2
5	Cable	UL2725 28AWG*1P+24AWG*2C+AEB65% Color: Black, OD=4.7mm	1
4	USB Type C 3.1	Housing: Thermoplastic, Color: Black Contacts: Copper Alloy, Finish: Au Plated Shell: Stainless Steel, Finish: Au Plated	1
3	Cable	UL2725 (1P*28AWGEAM)*2+(1PR*28AWG+A)+2C*24AWG+AB 85% Color: Black, OD=5.0mm	1
2	USB-A 3.0 Receptacle	Housing: Thermoplastic, Color: Blue Contacts: Copper Alloy, Finish: Au Plated Shell: Copper Alloy, Finish: Au Plated	1
1	Housing	Thermoplastic Color: Black	1
Item	Part Name	Material / Finish	Qty

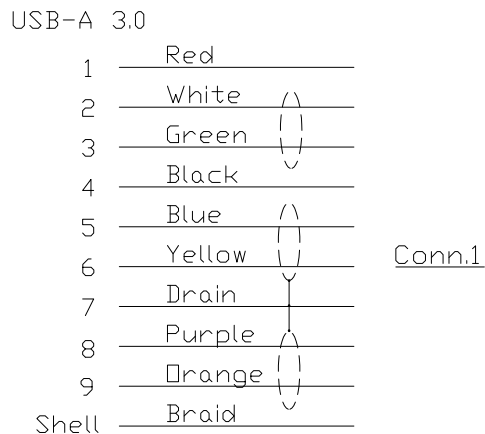
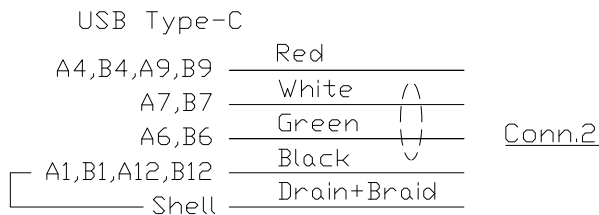

Wiring Diagram

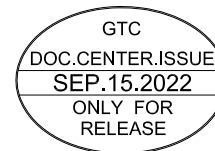

GT Contact CO.,LTD

NOTICE OF PROPRIETARY PROPERTY:
 THE INFORMATION CONTAINED HEREIN IS THE PROPRIETARY PROPERTY OF GT Contact CO.,LTD THE POSSESSOR AGREES TO THE FOLLOWING:
 (a) TO MAINTAIN THIS DOCUMENT IN CONFIDENCE
 (b) NOT TO REPRODUCE OR COPY IT
 (c) NOT TO REVEAL OR PUBLISH IT IN WHOLE OR PART
 (d) ALL RIGHTS RESERVED

TITLE						DRAWING NUMBER			REV.
USB-A3.0 + Type-C C4 Panel Square Flange Dual-USB JACK With Cable + Cap						GT11F443-0F-XX			01
	B	1:1	Hank 09/13/22	Lucas 09/13/22	Ray 09/13/22	X.X ± 0.5 X.XX ± 0.2	X.XXX ± 0.05 ANGLES ± 1°	mm	2/2
THIRD ANGLE PROJECTION	SIZE	SCALE	DRAW / DATE	CHECK / DATE	APPROVE / DATE	TOLERANCES		UNIT	SHEET

1

2

3

4